

VSB12

NATIONAL CODE OF PRACTICE

Rear Marking Plates

For all motor vehicles over 12 tonnes GVM
and for all trailers over 10 tonnes GTM

Vehicle Standards Bulletin (VSB) 12 - Rear Marking Plates

Background

It is a regulatory requirement that marking plates be placed on the rear of certain motor vehicles and trailers in order to improve their visibility and to provide the *do not overtake turning vehicle* warning to other motorists.

This bulletin identifies the types of plates that can be used, where they are placed on the vehicle and the methods for installing them.

Class 400, Class 1A, UNECE R70 and Class 2 rear marking plates

Although rear marking plates installed on heavy vehicles and trailers must be retroreflective, i.e. made of a material that reflects an incident light beam directly back to its source, they cannot be used in place of other reflectors required by Australian Design Rules (ADRs) or vehicle safety standards.

Rear marking plates can be manufactured from three classes of reflective material:

Class 400	Class 400 material that complies with AS/NZS1906.1
Class 1A	Class 1A material that complies with AS/NZS1906.2
UNECE R70	Material that complies with the relevant requirements of UNECE Regulation 70

All rear marking plates on a vehicle must be complimentary and made of the same reflective material.

Class 2 plates to be discontinued

As part of the 2016/17 review of AS4001, it was determined that Class 400 and 1A plates were more durable, offered improved retroreflective performance, and could be smaller than Class 2 plates. Accordingly, use of Class 2 rear marking plates has been discontinued, and only Class 400, Class 1A and UNECE R70 plates are now to be used.

Managing the transition

Class 2 plates already fitted to vehicles are being phased out gradually. Operators will be permitted to continue using Class 2 plates that are already fitted to their vehicle until they require normal replacement because the plates are damaged, have faded or are being replaced as they are incorrectly fitted.

From 1 January 2021, when an operator needs to replace the Class 2 plates fitted to a vehicle, the plates must be replaced with Class 1A, Class 400 or UNECE R70 marked plates.

The fitting of new Class 2 plates to a vehicle after 31 December 2020 is prohibited.

Categories of rear marking plates

Rear marking plates are categorised according to their overall width and height and are assigned a code on this basis: for example, a 300mm wide x 100mm high plate is designated as Category 31.

- Category 31L and 33L plates only feature the **DO NOT OVERTAKE TURNING VEHICLE** message (known as a *legend*), indicated by the letter **L** after the category number.
- Category 33 plates are marking symbols only.
- Category 34A and 34B plates combine marking symbol and legend, with letters A or B to indicate direction of the symbol.
- Category 161, 81 and 41 plates are strip plates with the letter A, B or C to indicate the direction of the colour bands on the plate.

For examples of these plates are provided in the *Rear Marking Plates – Summary Sheet* on page 4 and 5.

Plate functions

- *Legend only* plates provide instructions to motorists travelling behind the vehicle not to overtake the vehicle when it is turning.
- *Symbol and strip plates* indicate the left and right extremities of the vehicle and increase visibility.

Plate and sign selection requirements

The types of vehicles on which rear marking plates must or may be placed is determined by their Gross Vehicle Mass (GVM) or Gross Trailer Mass (GTM).

The types of vehicles or combinations on which the *do not overtake turning vehicle* message must or may be fitted is determined by the length of the vehicle or combinations and how the vehicle performs when turning at intersections.

Must be fitted

The following vehicles **must** be fitted with rear marking plates:

- motor vehicles with GVM over 12 tonnes (NC category)
- trailers with GTM over 10 tonnes (TD category)
- buses with GVM over 12 tonnes (certain ME category), except those fitted with hand grips or similar equipment for standing passengers (e.g. route service buses used solely in urban areas)

May be fitted

The following vehicles **may** be fitted with rear marking plates:

- any motor vehicle less than 12 tonnes GVM
- any trailer less than 10 tonnes GTM

Do not overtake turning vehicle signs

The obligation to provide the *'do not overtake turning vehicle'* warning is a road rule as applicable in each jurisdiction and applies equally to heavy and light vehicles and combinations.

- Vehicles or combinations 7.5m or more in length that have to straddle lanes or turn from an adjacent lane in order to turn at intersections **must** display warning the *'do not overtake turning vehicle'* message.
- Vehicles or combinations with a combined length of less than 7.5m **must not** be fitted with the *'do not overtake turning vehicle'* message.

📌 For vehicles in NSW, larger *'do not overtake turning vehicle'* signs than those specified in this VSB are required. For more information about these local requirements, please contact Transport for New South Wales

Plate selection and combination

Legend and symbol plates may be used in various combinations with strip plates on the rear of the vehicle (see examples provided in the *Rear Marking Plates – Summary Sheet* on pages 4 and 5).

If space permits on the rear of the vehicle:

- Use Category 33 and 34 plates as first choice.
- Use additional strip plates if possible for added visibility.

If Category 33 plates are selected:

- Use them in correct configuration with either 31L or 33L plates.
- Use additional strip plates if possible for added vehicle visibility.

If Category 34 plates are selected:

- Use a 33 plate on the right with a 34A plate on the left, or use 34 plates on both sides.
- Use additional strip plates if possible for added vehicle visibility.
- Category 34 plates cannot be used on a vehicle/combo that is less than 7.5m in length.

If rear of the vehicle cannot support Category 33 and 34 plates:

- Use the Category 161 strip plate as space permits.
- Use them in conjunction with 31L and 33L plates if required.

If a single 161 plate cannot be used:

- Use the correct combination of 81 and 41 plates.
- Use these in conjunction with 31L and 33L plates if required.

If vehicle is a prime mover, lead semitrailer or converter dolly:

- Use 615 plates only.
- Use in conjunction with 31L and 33L plates if required.

Installation Requirements

Plates must be positioned and configured in accordance with the following requirements and recommendations.

Plate positioning

Required:

- When installing rear marking plates, locate them at the height above road surface and distance in from the outer edge of the vehicle as specified in the Rear Marking Plates – Summary Sheet (pages 5 and 5).

Outer edge

is measured from the outside edge of the plate to the widest part of the vehicle on the same side. When determining the widest part, do not include items normally excluded from vehicle width such as rear vision mirrors, side lights, etc (see Figure 1).

Height

is measured from the ground to bottom edge of the plate when the vehicle is un-laden and parked on a flat horizontal surface (see Figure 1).

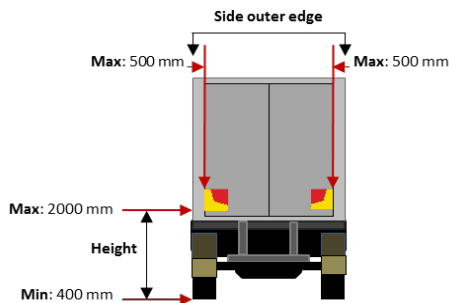


Figure 1. Example - Positioning dimensions

- Locate plates on a rear, near-vertical surface (do not exceed 5° to the vertical) and at near-right angles (85-95°) to the longitudinal axis of the vehicle (parallel to the rear axle).
- Install all non-strip plates as close as possible to the outside edge of the vehicle.
- Ensure that plates intended to complement each other on opposite sides of a vehicle are of the same size.
- Keep plates clean and in good condition and do not obscure plates behind other parts of the vehicle, load or tarpaulins.
- Follow the orientation instructions of the plate manufacturer, and ensure colour bands of all strip plates slope down and outward away from the centre of the vehicle.
- Do not mix Class 400, Class 1A and UNECE R70 rear marking plates on a vehicle as they have different retroreflective material properties.

Recommended:

- Position pairs of marking plates symmetrically about the vehicle centreline and at the same height from the ground.
- On vehicles with skeleton structures, such as skeleton container trailers, attach plates to fabricated supports clear of the load or to moveable panels that can be swung aside for loading (similar systems are used on vehicles such as boat trailers to mount registration plates and rear lamps).
- On vehicles with tip-up loading ramps, such as car carriers, attach the marking plates to the underside of the ramps.

Markings

Compliant plates are required to display certain information. Plates without this information or that are worn so that the information can no longer be read are not acceptable for road use.

Required:

- Ensure the front reflective surface of the plate bears the following information in text that is no more than 3mm in height:
 - the name of the manufacturer or agent,
 - AS4001.1 and
 - the class of retroreflective material.

Example markings:

- “Acme Manufacturing AS4001.1 Class 1A”
- “Acme Manufacturing AS4001.1 Class 400”
- “Acme Manufacturing AS4001.1 UN R70”

UNECE R70 plates may also show an approval mark as required by that regulation.

- Ensure plates display letters indicating the correct orientation on the vehicle.



Bending

Recommended:

- Avoid bending plates to suit the contour of a mounting surface as it may damage the cellular retroreflective structure of the material and reduce optical performance and durability.
- Use pressure sensitive adhesive backed plates on curved surfaces.

Cutting

Cutting or making holes (for example by drilling or punching) is not permitted.

Strip plates may be cut in order for them to be fitted to the vehicle.

Recommended:

- Avoid cutting strip plates to suit a restricted space or to span fixed and moveable sections of the vehicle.
- If cutting is unavoidable, only remove a strip of material not wider than 10mm, and fit so that overall dimensions of the plates are maintained (see Figure 2).

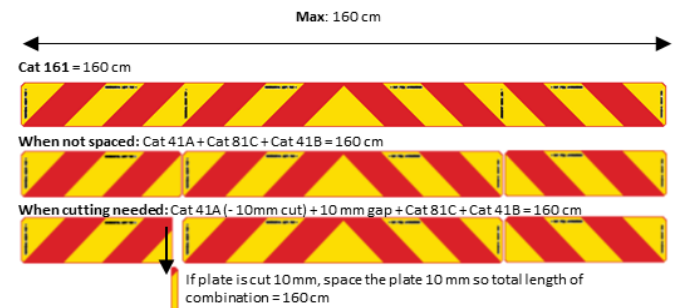


Figure 2. Example - Cutting

Fastening metal backed plates

Recommended:

- If the rear marking plate is installed against dissimilar metal, install a spacer or synthetic (electrically insulating) material between the two surfaces to prevent chemical and electrical corrosion.
- Ensure fasteners are of compatible material to minimise corrosion. Place a synthetic washer beneath the head of each fastener during installation to prevent surface damage to the retroreflective surface. If installing on electroplated steel, self-tapping screws are not recommended.
- Use pressure sensitive adhesive to affix the plates rather than damaging the vehicle by welding a bracket to, or drilling holes in, the vehicle.
- Ensure the fastening method can withstand normal in-service cleaning and chemicals so that the plate can meet the solvent resistance performance and maintenance durability requirements specified in AS4001.1.

Fastening pressure sensitive plates

Required:

- Prepare application surfaces for pressure sensitive plates in accordance with the plate manufacturer's instructions.

Acknowledgements

This information has been published by the West Australian Department of Transport with the assistance of the National Heavy Vehicle Regulator, the Australian Motor Vehicle Certification Board and Standards Australia.

Figures 3-9 are reproduced from AS4001. © Standards Australia Limited. Copied by the National Heavy Vehicle Regulator with the permission of Standards Australia under Licence 1611-c024.

Publication History

Revision	Date published
Version 1	June 2006
Version 2	November 2017
Version 2.1	July 2018
Version 2.2	July 2020

Rear Marking Plates – Summary sheet

Cat	Size (mm)	Appearance	Location - Height/Distance (mm)			Function	Description	Configuration
			Location	Prefer	Max			
31L	W: 300 x H: 100		Location			Provides instruction to other motorists. Used in conjunction with Category 33 or strip plates (41, 81, 161 and 615).	Black letters on yellow retroreflective background.	Required for vehicles > 7.5m in length that straddle turning lanes: <ul style="list-style-type: none"> fit sign to the left-hand side of the rear of the vehicle when a 34A marking plate is not used. Recommended for vehicles > 7.5m in length: <ul style="list-style-type: none"> fit sign to the left-hand side of the rear of the vehicle when a 34A marking plate is not used.
			Outer edge	0	500			
33L	W: 300 x H: 300		Location			Indicate left and right extremities of vehicle. There is only one Category 33 sign but it can be used on the left or right of the rear of the vehicle by orienting it as required.	Red symbol on yellow retroreflective background. Directions (LH TOP and RH TOP) provided on corners of plate to indicate correct angle of orientation.	Required: <ul style="list-style-type: none"> Position pair of Category 33 plates on the rear surface of vehicle at the same height, symmetrically about the longitudinal centre-line of the vehicle as in <i>Figures 3 and 4</i>. For applicable vehicles locate a Category 31L or 33L plate on this surface at the left-hand side of the rear of the vehicle above the Category 33 plate OR use a Category 34 plate instead of the left oriented Category 33 plate.
			Outer edge	0	500			
33	W: 300 x H: 300		Location			Indicate left and right extremities of vehicle and provides instruction to other motorists.	Black letters and red symbol on yellow retroreflective background.	Required: <ul style="list-style-type: none"> Install Category 34A plate on the left side of the rear of the vehicle in conjunction with corresponding Category 34B or Category 33 plate in correct orientation at the right side of the rear of the vehicle as in <i>Figures 5 and 6</i>. Position both plates symmetrically along the longitudinal centre-line of the vehicle and at the same height as in <i>Figure 6</i>.
			Outer edge	0	500			
34A + 34B	W: 300 x H: 400		Location			Indicate left and right extremities of vehicle and provides instruction to other motorists.	Black letters and red symbol on yellow retroreflective background.	Required: <ul style="list-style-type: none"> Install Category 34A plate on the left side of the rear of the vehicle in conjunction with corresponding Category 34B or Category 33 plate in correct orientation at the right side of the rear of the vehicle as in <i>Figures 5 and 6</i>. Position both plates symmetrically along the longitudinal centre-line of the vehicle and at the same height as in <i>Figure 6</i>.
			Outer edge	0	500			
34B	W: 300 x H: 400		Location			Indicate left and right extremities of vehicle and provides instruction to other motorists.	Black letters and red symbol on yellow retroreflective background.	Required: <ul style="list-style-type: none"> Install Category 34A plate on the left side of the rear of the vehicle in conjunction with corresponding Category 34B or Category 33 plate in correct orientation at the right side of the rear of the vehicle as in <i>Figures 5 and 6</i>. Position both plates symmetrically along the longitudinal centre-line of the vehicle and at the same height as in <i>Figure 6</i>.
			Outer edge	0	500			
34B	W: 300 x H: 400		Location			Indicate left and right extremities of vehicle and provides instruction to other motorists.	Black letters and red symbol on yellow retroreflective background.	Required: <ul style="list-style-type: none"> Install Category 34A plate on the left side of the rear of the vehicle in conjunction with corresponding Category 34B or Category 33 plate in correct orientation at the right side of the rear of the vehicle as in <i>Figures 5 and 6</i>. Position both plates symmetrically along the longitudinal centre-line of the vehicle and at the same height as in <i>Figure 6</i>.
			Outer edge	0	500			

Figure 3. Road tank vehicle with Category 33 plates

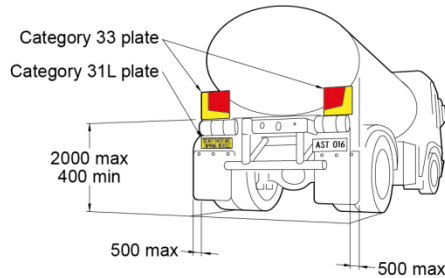


Figure 4. Semitrailer/flat deck vehicle with Category 33 and 31L plates

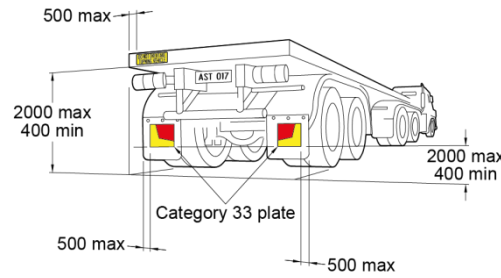


Figure 5. Omnibus with Category 34A and 33 plates

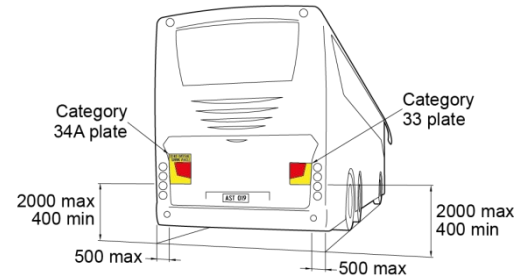
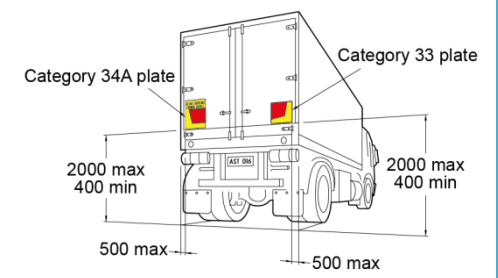


Figure 6. Rigid truck with Category 34A and 33 plates










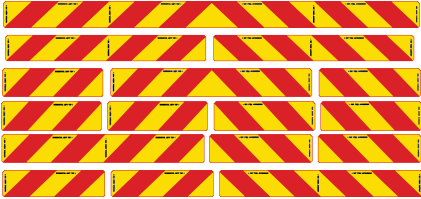

Cat	Size (mm)	Appearance	Location - Height/Distance (mm)			Function	Description	Configuration
41A + 41B	W: 400 x H: 100	41A  41B	Location	Prefer	Max	Increase the visibility of the vehicle.	Red transparent stripes on yellow retroreflective background.	Required: Use the Category 161 strip plate, as space permits, in conjunction with 31L and 33L plates. If Category 161 strip plate cannot be used then consider the following options:
			Outer edge	0	500			
						Used in conjunction with 31L or 33L plates of slant.		
			Height	400-1500	2000			
81A	W: 800 x H: 100	 = 1 x 81A  = 2 x 41A						
81B	W: 800 x H: 100	 = 1 x 81B  = 2 x 41B						
81C	W: 800 x H: 100	 = 1 x 81C 41A  41B	Location	Prefer	Max			
			Plate centre	On vehicle centre line				
			Height	400-1500	2000			
161	W: 1600 x H: 100							
615A+ 615B	W: 600 x H: 150	615A  615B	Location	Prefer	Max	Only installed on vehicles with a fifth wheel coupling at the rear and without suitable structure that would allow use of Category 33 or 34 plates.	Red transparent stripes on yellow retroreflective. Used in conjunction with 31L or 33L plates.	Required: • Install Category 615A and 615B rear marking plates with the longer edge horizontal (see Figure 9). • Fit vehicle or trailer with a pair of Category 615 strip plates, or with alternative configurations (for Category 34 or Categories 161, 81 and 41). • Install these on a surface (e.g. mud flaps) at the rear of the vehicle and position them at the same height.
			Outer edge	0	200			
			Height	300-1500	2000			

Figure 7. Vehicle carrier with 31L and vertical and horizontal strip plates

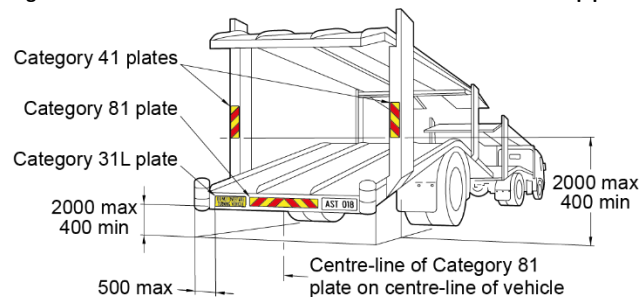


Figure 8. Log trailer/jinker with 31L and 161 strip plate

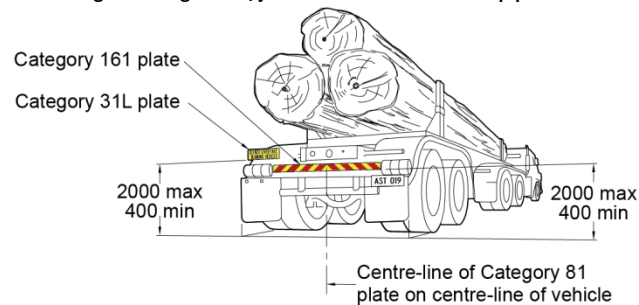


Figure 9. Prime mover with 615A and 615B strips and 31L plate

